

NITROX

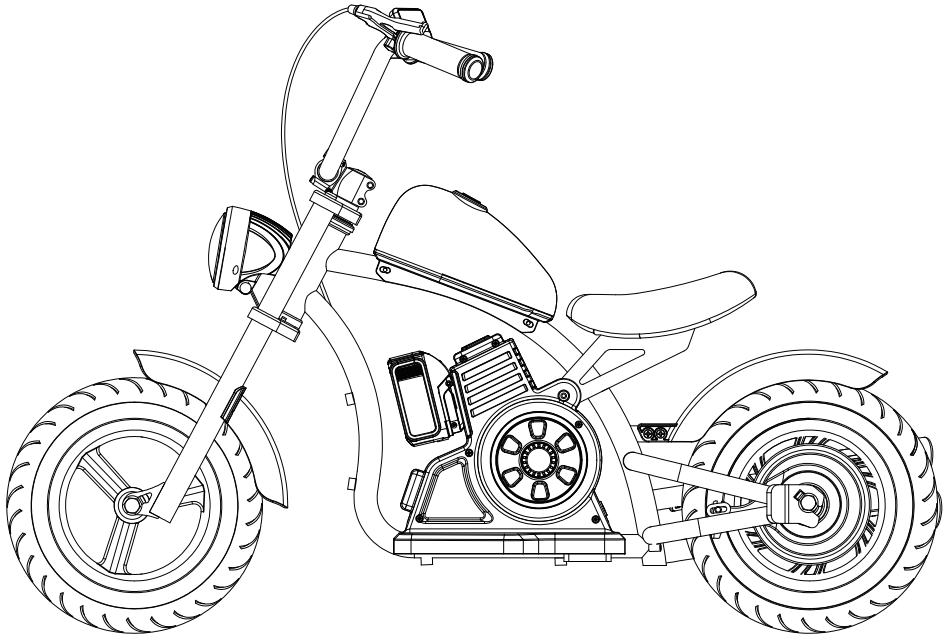

User manual

KIDS ELECTRIC MOTORCYCLE

Nitrox Chopper Jr.

*Product images are for illustration purpose only. Actual product may vary.

Product Description

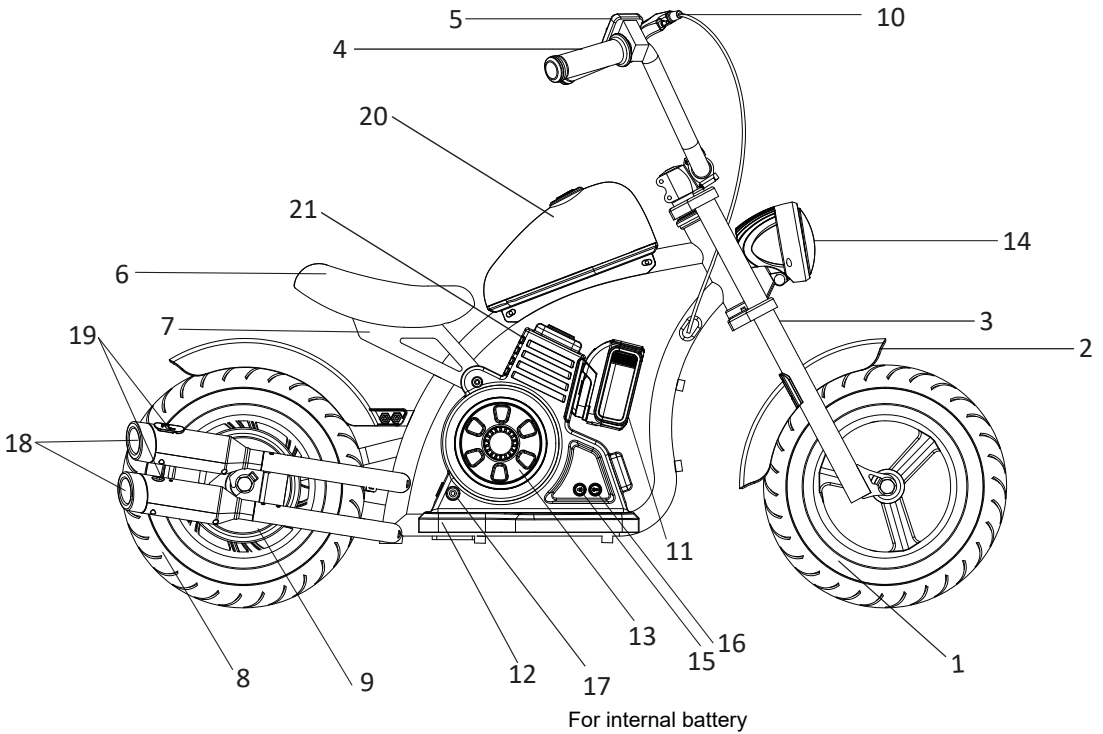

- | | | |
|--------------------------|---------------------|------------------|
| 1. front wheel | 2. fender | 3. front fork |
| 4. handlebar | 5. display screen | 6. seat |
| 7. seatpost clamp | 8. rear wheel | 9. hub motor |
| 10. brake | 11. lithium battery | 12. pedal |
| 13. controller | 14. front light | 15. sound switch |
| 16. spray switch | 17. charging hole | 18. spray outlet |
| 19. water injection hole | 20. garnish | 21. flash device |

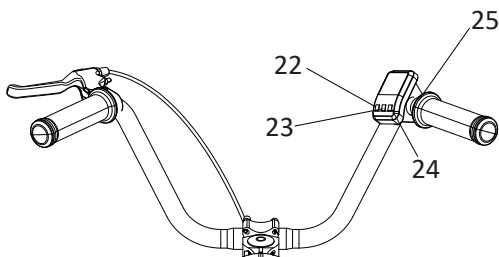

- | |
|-------------------|
| 22. turn ON/OFF |
| 23. gear increase |
| 24. gear down |
| 25. throttle |
| (with roaring) |

Important safety instructions

Please read these safety instructions and respect the following warnings before the appliance is operated:



The lightning flash with arrowhead symbol, within an equilateral triangle, is intended to alert the user to the presence of uninsulated "dangerous voltage" within the product's enclosure that may be of sufficient magnitude as to constitute a risk of electric shock to persons.



The exclamation point within an equilateral triangle is intended to alert the user to the presence of important operating and maintenance (servicing) instructions in the literature accompanying the appliance.



This symbol means that the product should be disposed of in an environmentally friendly manner and not with general household waste.

In order to prevent fire always keep candles and other open flames away from this product



Nordbutiker AB is not liable for Injury/death caused by misuse.

- Parents or Adult is requested to read this manual carefully.
- Child under 3 years old is not suggested to ride the bike.
- Child is only allowed to ride under the supervision of a parent and adult.
- Nordbutiker AB are not liable if the user does not follow the local laws and restrictions.
- The warranty does not cover damages caused by improper use of the device, especially in case use for non-domestic purposes and alterations and / or adaptations necessary for countries or regions, for which it was not originally designed.
- Always abide by local traffic rules and national laws, and regulations while using your bike.
- Always adhere to the local speed limit. DO NOT exceed the speed limit for the bike.
- Always wear safety protection equipment when in use.
- Always wear a safety helmet when riding your bike.
- Always wear elbow pads, knee pads when riding.
- Always ride with both hands holding the handles, never ride with one handed.
- Do not ride in bad weather.
- Do not use this bike to perform stunts or dangerous maneuvers. This scooter is designed for domestic use.
- Ride slowly in crowded places.
- Ensure that all screws and fasteners are tight and normal before use.
- Make sure that the seat tube is adjusted to a suitable height and the clamp is tightly fastened.
- Do not ride on uneven roads, water, oil or ice.
- Do not weave through traffic or make moves which are unpredictable to other people.
- Do not use the bike if it is damaged.
- Do not use the e-scooter if the battery emits a peculiar smell and/or heats up.
- Do not use the e-scooter if liquid leaks out of it, avoid contact and place out of the reach of children.
- Before use, ensure that the bike is not damaged. Do not ride if there is any damage.
- Ensure that you read all of this User Manual before using the bike.
- Learn how to ride the bike before using in a public space. Propulsion is via an electric motor located in the driving wheel.
- Only one person may ride on the bike.
- Do not modify this bike in any way.
- Do not use any parts or accessories unless recommended or approved by Nordbutiker AB

- Ride the bike on level surfaces. Do not exceed the specified incline.
- Excessive use will reduce the lifetime of this bike.
- Caution, brakes and associated parts may become hot during use. Do not touch after use.

Battery and Charger Warnings

- Do not power on the bike while charging.
- Remove the battery from the bike and charge.
- After the battery is fully charged, disconnect the charging cable.
- The battery indicator in the display will show the battery lifetime.
- If the battery indicator has one bar left, stop riding and charge the battery.
- Charge the battery after every use.
- If the e-scooter is not used for a long time, charge it at least once a month. Note that if the battery is not charged for a long time, the battery will enter a self-protection state and will fail to charge. In this case, please contact your dealer.
- When charging, plug the charger into the charging port before plugging to the wall socket.
- While charging the indicator light of the charger is red, this means the charging is normal; When the indicator light turns green, charging is complete.
- Only use the original charger to charge the battery.
- Dispose of batteries and bikes in compliance with the applicable regulations in your country.

Disposal of this equipment and batteries

- Observe the correct polarity when inserting the batteries.
- Do not expose batteries to high temperatures and do not place them in locations where the temperature might increase quickly, e.g. near fire or in direct sunshine.
- Do not expose batteries to excessive radiant heat, do not throw them into the fire, do not disassemble them and do not try to recharge non-rechargeable batteries; they could leak or explode.
- Disposal of a battery into fire or mechanically crushing or cutting a battery can result in an explosion.
- Leaving a battery in an extremely high temperature surrounding environment can result in an explosion or the leakage of flammable liquid or gas.
- A battery subjected to extremely low air pressure may result in an explosion or the leakage of flammable liquid or gas.



CE statement

- Here we declare that this motorcycle is in compliance with the essential requirements and other relevant provisions of EN71-1, EN71-2, EN71-3 IEC 62115, EMC, ROHS etc.

UL statement

- Here we declare that this motorcycle is in compliance with the essential requirements and other relevant provisions of ASTM F963, CPSIA etc.

What's in the Box

- Electric Motorcycle For Kids
- User Manual
- 1 × Allen L-shaped wrench 4mm
- 1 × Allen L-shaped wrench 3mm
- 2 × Open-end Wrench 16mm
- 1 × Charger
- 2 × Gaskets
- 1 × Screw
- 2 × Nuts

bike



battery

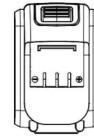

charger



tool pack

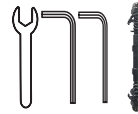

owner's manual

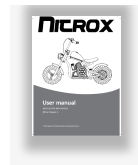

Assembling

It's required to be assembled by an adult

Assembling the Front Wheel

- Place the front wheel in the middle of the front fork so that the axle of the front wheel is aligned with the bottom hole of the front fork;
- Insert the screw into the axle of the front wheel through the hole of the front fork; use two gaskets to fix at both ends of the front fork;
- Use 2 nuts to fasten the bolt at both ends, and use the open wrench to lock the nuts tightly.

Assembling the Handlebars

- Remove the stem cover from the stem by loosening 4 screws with allen key;
- Install the handlebar and place it in the middle position. Lock the cover with 4 screws again. If the handlebar is not in a middle position, gently correct it and fasten the handlebar.

Assembling the Battery

- Insert the battery from the side with clip to the battery holder on bottom of the bike, make sure battery is tightly clasped.

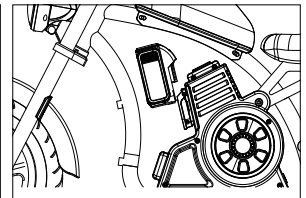
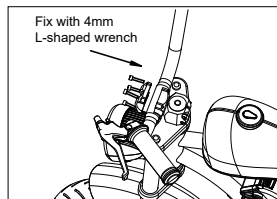
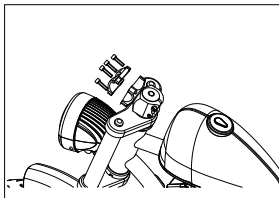
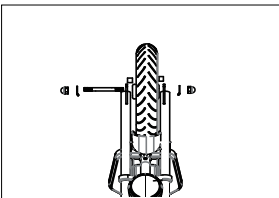

Fender installation

- Align the holes on the gaskets on both sides of the front fender with the holes of the front forks on both sides.
- Secure the fender by tightening the screws

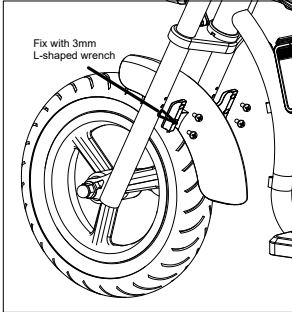

- Align the holes in the rear fender gasket with the holes in the frame gasket.
- Secure the fender by tightening the screws

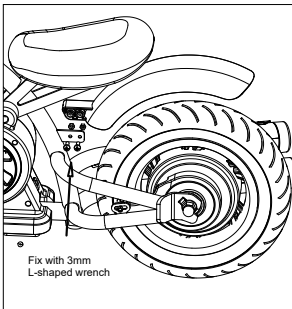

Battery Removal and Charging Battery

- Push the clip on the battery then pull out with a force.
- Plug the charger to the battery charge port.
- Plug the charger to the mains wall socket.
- When connected to the battery charger, the battery will start to charge and the charge indicator on the charger will turn red. After the charging is complete, the charge indicator will turn green; disconnect the battery charger when fully charged.

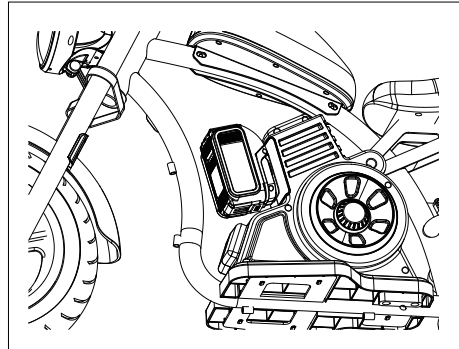

NOTES

- If the motorcycle is not being used regularly, it is recommended to charge the battery every month.
- Do not charge the battery outside.
- Do not charge if the cable or motorcycle is wet.
- Do not charge when the motorcycle is powered on.

Using the motorcycle

- Make sure that the battery is sufficiently charged.
- Hold the handles correctly and seat on the bike.
- Keep the ON/OFF button pressed to switch on.
- Briefly press the key to select the desired level of speed (from "1" to "3").
- Twist the throttle inward and kick to forward with both feet to drive.

To decelerate:

- Release the right twist handle(not let go right hand on the handle).
- Slow down with feet touching the ground.

Technical Specification



Model	Nitrox Chopper Jr.
Dimensions (L x W x H)	1160 x 600 x 830 mm
Wheel Size	12inch
Wheel Type	Inflatable
Frame Material	Steel
Weight	13.5Kg
Maximum Load	75Kg
Speed Mode	3 Speed: 8/12/16Kmh
Range per Charge	10~13Km (with battery)
Accelerator	Twist
Brake Type	Drum Brake
Motor Type	Brushless
Motor Power	160W
Recommended Age	3~6 years
Battery	
Battery Type	Lithium
Battery Capacity	4Ah
Battery Voltage	18,5V
Battery Power	74Wh
Battery Charger	
Input	100-240V ~1A(Max) 50/60Hz
Output	21V 0,8 A
Charging Time	4hours

CE UL

Made in China

Nordbutiker AB
Gösvägen 28, 76141 Norrtälje, Sweden

 Info@rull.se
 info@rull.dk

 info@ruller.no
 info@rull.fi